

PUMP, 3000@2.4 W/O PB 12 DEG WOBBLE PLATE
PART NO. 510014

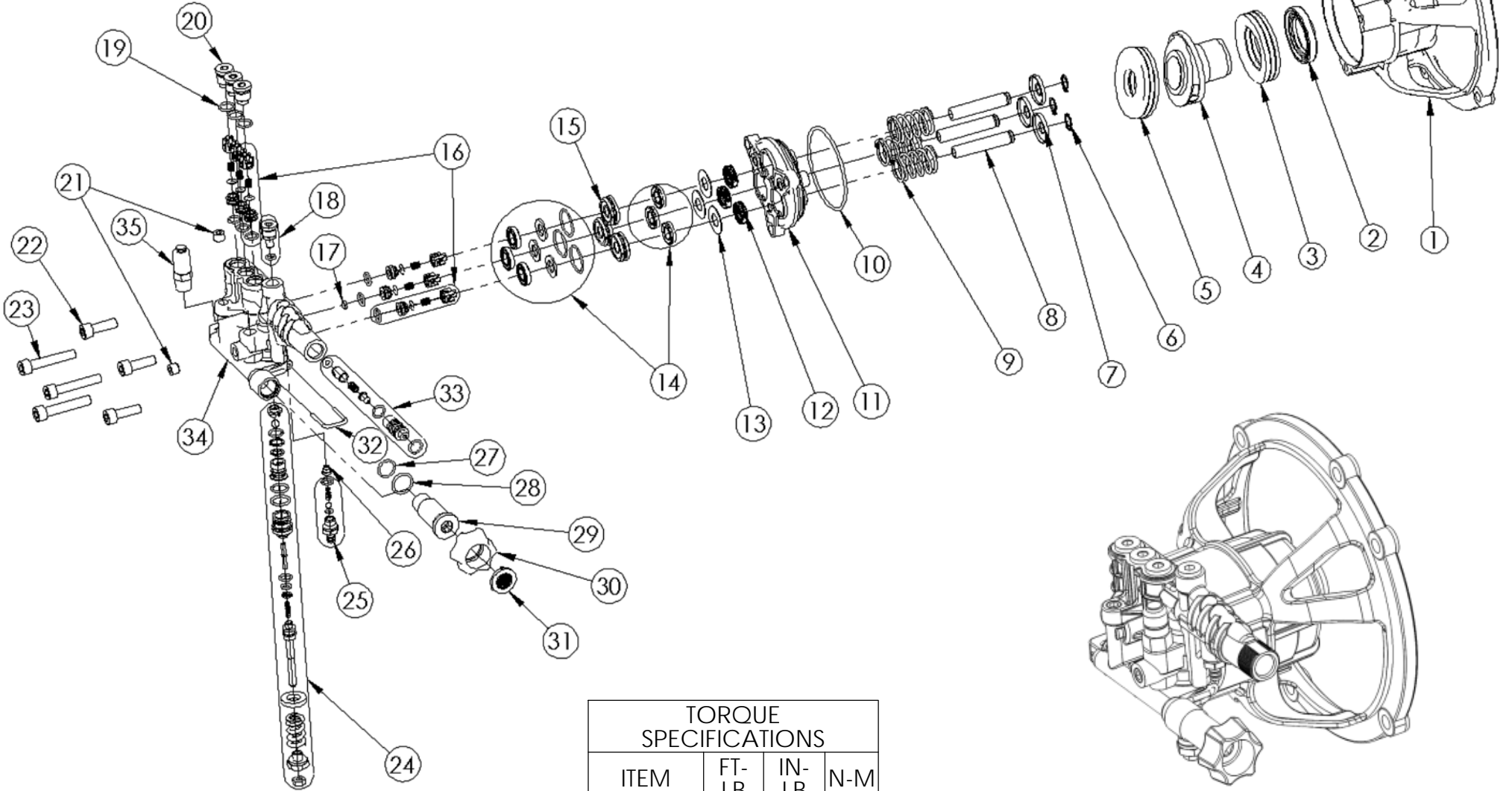

TORQUE SPECIFICATIONS			
ITEM	FT-LB	IN-LB	N-M
18	13	159	18
20	13	159	18
22	16	195	22
23	18	221	25
25	10	115	13
29	13	159	18

	NAME	DATE
DRAWN	KDB	6/4/15
CHECKED	GN	6/4/15
ENG APPR	SAC	6/5/15
MFG APPR.	-	-
Q.A. APPR.	-	-
SERVICE APPR.	-	-

FNA-GROUP
1265 INDUSTRIAL STREET, DECATUR, AR 72722
TITLE:
PUMP, 3000@2.4 W/O PB
12 DEG WOBBLE PLATE

PROPRIETARY AND CONFIDENTIAL
THE INFORMATION CONTAINED IN THIS DRAWING IS THE SOLE PROPERTY OF FNA-GROUP. ANY REPRODUCTION IN PART OR AS A WHOLE WITHOUT THE WRITTEN PERMISSION OF FNA-GROUP IS PROHIBITED.

SIZE	DWG. NO.	REV.
A	510014	B
SCALE: N/A	ECN# DC15-0061	SHEET 1 OF 5



12 PART NO. 7105741

OIL SEAL KIT		
ITEM	QTY	DESCRIPTION
1	3	SEAL, OIL

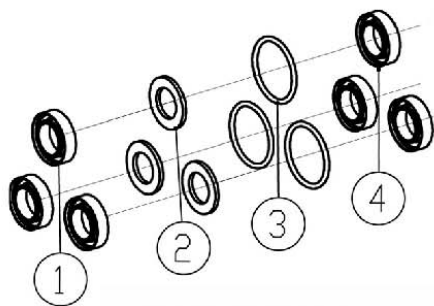

14 PART NO. 7106627

WATER SEAL KIT		
ITEM	QTY	DESCRIPTION
1	3	HIGH PRESSURE SEAL
2	3	BACK RING
3	3	O-RING
4	3	LOW PRESSURE SEAL

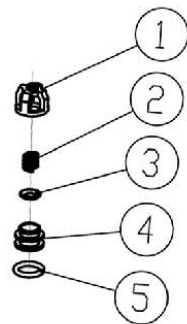

16 PART NO. 7104223

VALVE KIT		
ITEM	QTY	DESCRIPTION
1	6	VALVE CASE
2	6	SPRING
3	6	VALVE PLATE
4	6	VALVE SEAT
5	6	O-RING

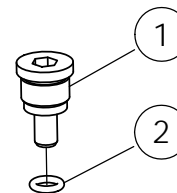

18 PART NO. 7108157

BOOST PLUG KIT		
ITEM	QTY	DESCRIPTION
1	1	BOOST PLUG
2	1	O-RING

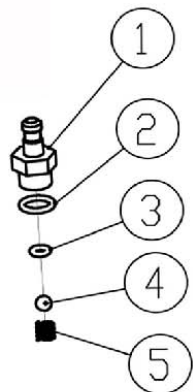

25 PART NO. 7104228

SOAP INJECTOR KIT		
ITEM	QTY	DESCRIPTION
1	1	HOSE BARB
2	1	O-RING
3	1	O-RING
4	1	STEEL BALL
5	1	SPRING

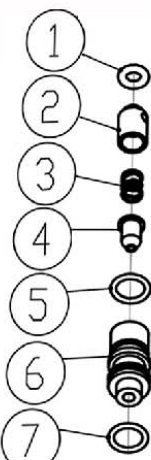

33 PART NO. 7106630

VENTURI TUBE KIT		
ITEM	QTY	DESCRIPTION
1	1	O-RING
2	1	CHECK VALVE CORE
3	1	CHECK VALVE SPRING
4	1	NOZZLE
5	1	O-RING
6	1	VENTURI TUBE
7	1	O-RING

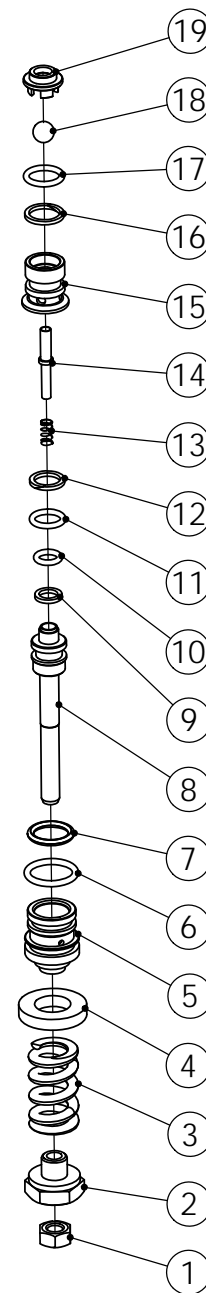

24 PART NO. 7104226

UNLOADER KIT		
ITEM	QTY	DESCRIPTION
1	1	NUT
2	1	ADJUSTING NUT
3	1	SPRING
4	1	SEATING RING
5	1	VALVE SHEATH
6	1	O-RING
7	1	O-RING
8	1	CHECKING RING
9	1	O-RING
10	1	VALVE POLE
11	1	SPRING
12	1	CHECKING RING
13	1	O-RING
14	1	PIN
15	1	UPPER SEAT
16	1	CHECKING RING
17	1	O-RING
18	1	STEEL BALL
19	1	BACK SEAT

510014 PUMP EXPLOSION DRAWING PARTS LIST

ITEM	PART NO.	PART NAME	QTY PER PUMP	COMMENT
1		Case	1	
2		Oil seal	1	
3		Thrusting Bearing 2	1	
4		Wobble Plate	1	
5		Thrusting Bearing 1	1	
6		Clip	3	
7		Spring Base	3	
8		Plunger	3	
9		Spring	3	
10		O-Ring	1	
11		Plunger Base	1	
12	7105741	Oil Seal	3	Oil Seal Kit
13	7106642	Back Ring	3	
14	7106627	High Pressure Water Seal	3	Water Seal Kit
		Back Ring		
		O-Ring		
		Low Pressure Water Seal		
15	7106643	Back Ring	3	
16	7104223	Valve Case	6	Valve Kit (INLET AND OUTLET)
		Spring		
		Valve Plate		
		Valve Seat		
17	7106644	O-Ring	1	
		O-Ring		
18	7108157	Boost Plug	1	Boost Plug Kit
		O-Ring		
19	7106645	O-Ring	3	
20	7106646	Plug	3	
21	7106647	Plug	2	
22	7106648	Screw	3	
23	7106649	Screw	3	

510014 PUMP EXPLOSION DRAWING PARTS LIST

ITEM	PART NO.	PART NAME	QTY PER PUMP	COMMENT
24	7104226	Nut	1	Unloader Kit
		Adjusting Nut		
		Spring		
		Seating Ring		
		Valve Sheath		
		O-Ring		
		O-Ring		
		Checking Ring		
		O-Ring		
		Valve Pole		
		Spring		
		Checking Ring		
		O-Ring		
		Pin		
		Upper Seat		
		Checking Ring		
O-Ring				
Steel Ball				
Back Seat				
25	7104228	Nozzle	1	Soap Injector Kit
		O-Ring		
		O-Ring		
		Steel Ball		
Spring				
26	7106650	Venturi Tube Back Ring	1	
27	7106651	O-Ring	1	
28	7106652	O-Ring	1	
29	7106653	Inlet Connector	1	
30	7106654	Nut	1	
31	7000123	Filter Gasket	1	
32	7106655	U-Pin	1	
33	7106630	O-Ring	1	Venturi Tube Kit
		Checking Valve Core		
		Checking Valve Spring		
		Nozzle		
		O-Ring		
Venturi Tube				
O-Ring				
34		Pump Head	1	
35	7101359	Thermal Relief Valve	1	

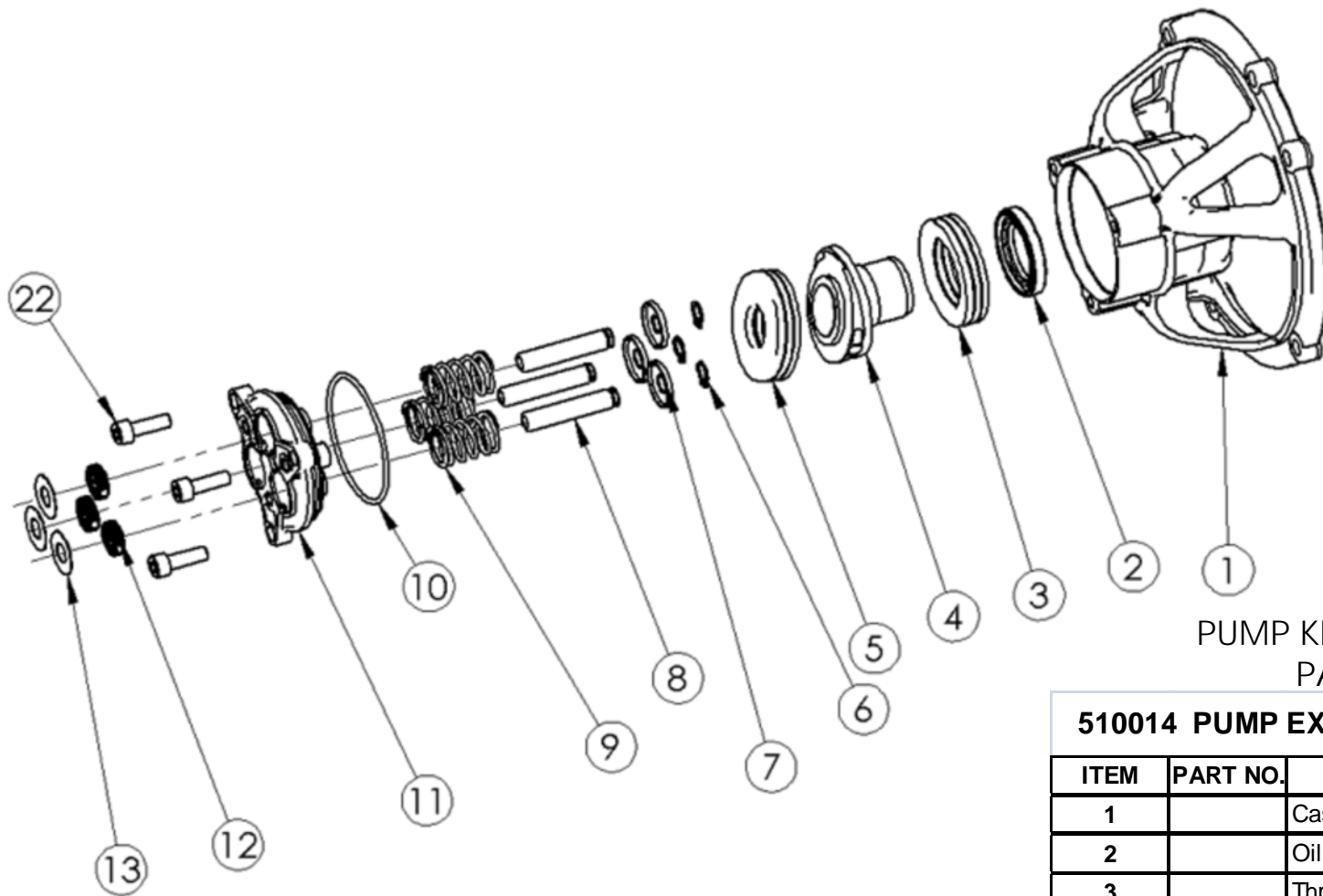

PUMP KIT, 510014 CRANKCASE
PART NO. 7108392

510014 PUMP EXPLOSION DRAWING PARTS LIST

ITEM	PART NO.	PART NAME	QTY	COMMENT
1		Case	1	
2		Oil seal	1	
3		Thrusting Bearing 2	1	
4		Wobble Plate	1	
5		Thrusting Bearing 1	1	
6		Clip	3	
7		Spring Base	3	
8		Plunger	3	
9		Spring	3	
10		O-Ring	1	
11		Plunger Base	1	
12		Oil Seal	3	Oil Seal Kit
13		Back Ring	3	
22		Screw	3	

PUMP KIT, 510014 MANIFOLD
PART NO. 7108366

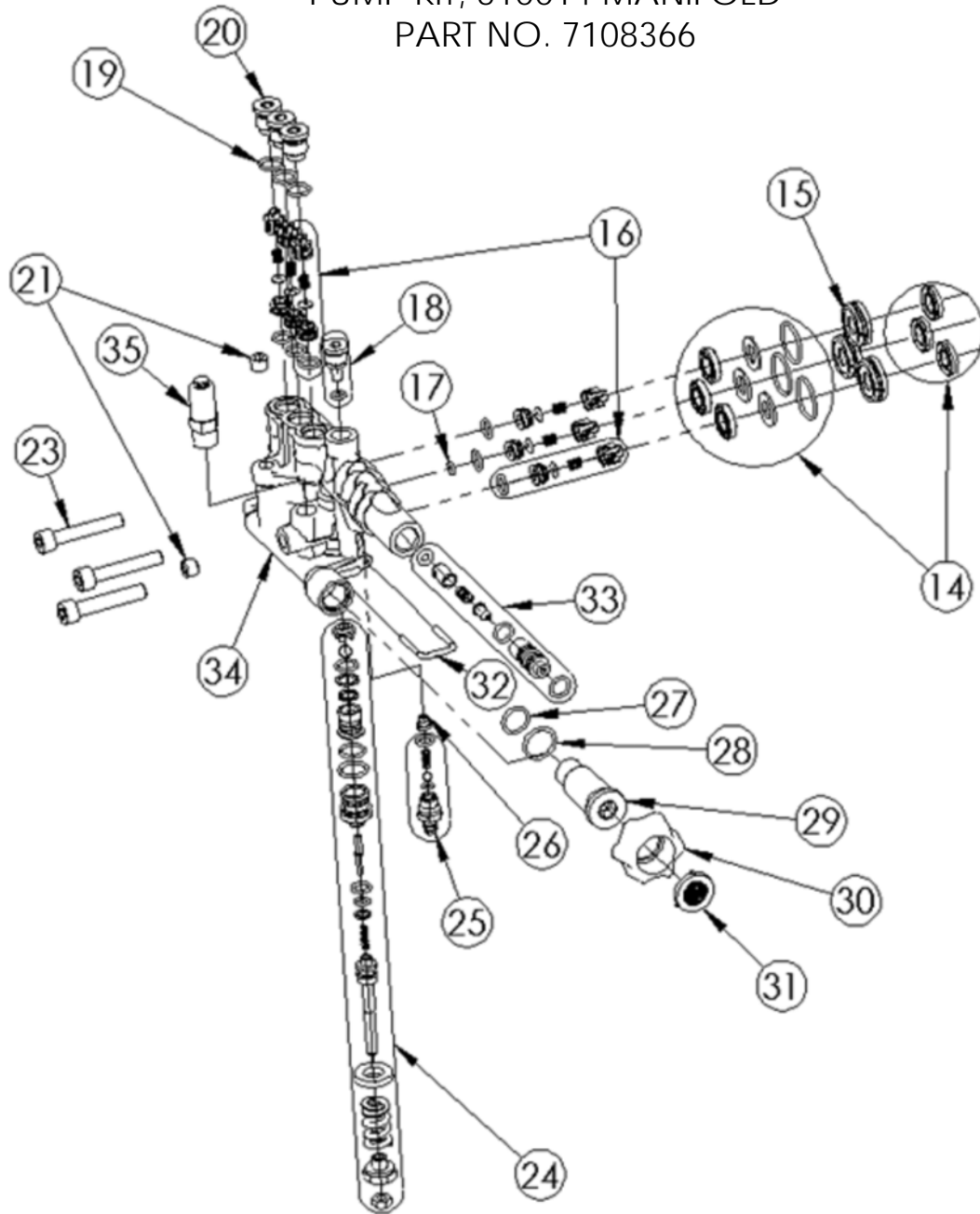

510014 PUMP EXPLOSION DRAWING PARTS LIST

ITEM	PART NO.	PART NAME	QTY	COMMENT
14		High Pressure Water Seal	3	Water Seal Kit
		Back Ring		
		O-Ring		
		Low Pressure Water Seal		
15		Back Ring	3	
		Valve Case		
		Spring		
		Valve Plate		
		Valve Seat		
16		O-Ring	6	Valve Kit (INLET AND OUTLET)
		O-Ring		
17		O-Ring	1	
18		Boost Plug	1	Boost Plug Kit
		O-Ring		
19		O-Ring	3	
20		Plug	3	
21		Plug	2	
23		Screw	3	
24		Nut	1	Unloader Kit
		Adjusting Nut		
		Spring		
		Seating Ring		
		Valve Sheath		
		O-Ring		
		O-Ring		
		Checking Ring		
		O-Ring		
		Valve Pole		
		Spring		
		Checking Ring		
		O-Ring		
		Pin		
25		Nozzle	1	Soap Injector Kit
		O-Ring		
		O-Ring		
		Steel Ball		
26		Spring	1	
		Venturi Tube Back Ring		
27		O-Ring	1	
28		O-Ring	1	
29		Inlet Connector	1	
30		Nut	1	
31		Filter Gasket	1	
32		U-Pin	1	
33		O-Ring	1	Venturi Tube Kit
		Checking Valve Core		
		Checking Valve Spring		
		Nozzle		
		O-Ring		
34		Venturi Tube	1	
		O-Ring		
35		Pump Head	1	
		Thermal Relief Valve	1	